

Typenblatt
Data Sheet

Modulares Spannsystem
Werkzeugaufnahme WHISTLE NOTCH
modular clamping system ; tool location WHISTLE NOTCH

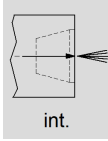

int. 80 bar
ext. bar

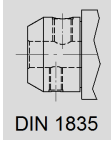
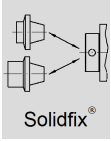
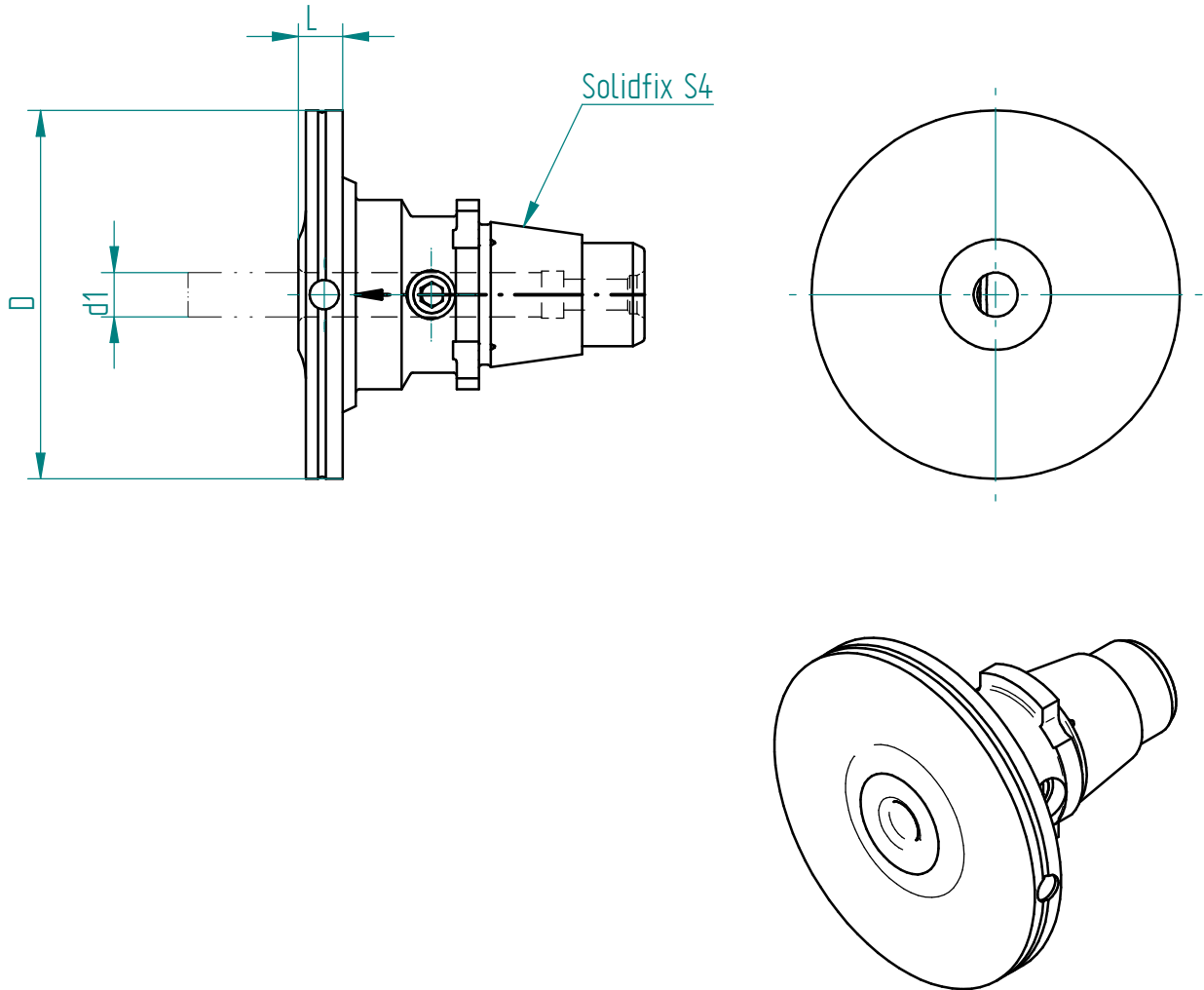

Schnittstelle Tooling interface tooling	D	L	Werkzeugaufnahme tool location Aufnahme d1 location d1	Bestell-Nr. order N°
Solidfix S4	63	7	DIN 1835 - E 6 6	140068

Zubehör Schlüssel:
accessories:

Rev 12/08 // Erst.:tba , erstellt am 2014.07.24 // Prüf.:fre , geprüft am 2014.08.21

Änderungen vorbehalten, Subject to modification