

Typenblatt  
Data Sheet

Modulares Spannsystem  
Werkzeugaufnahme WHISTLE NOTCH  
modular clamping system ; tool location WHISTLE NOTCH

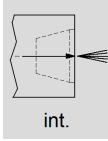

int. 80 bar  
ext. bar

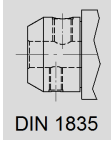
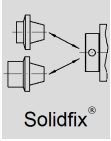
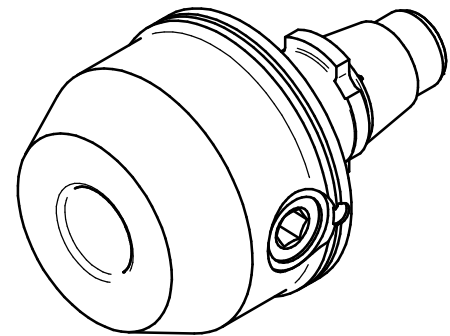
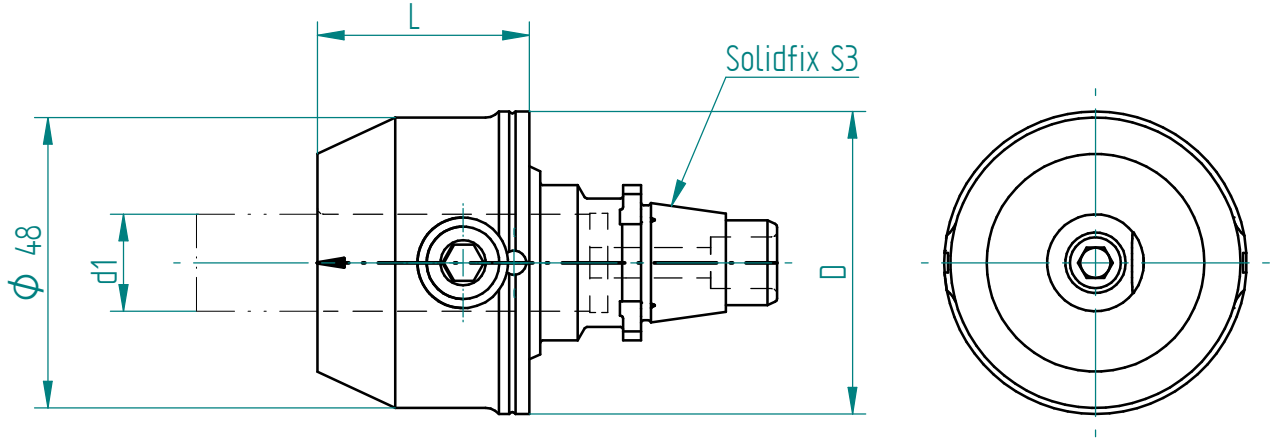

Schnittstelle Tooling interface tooling	D	L	Werkzeugaufnahme tool location  Aufnahme d1 location d1	Bestell-Nr. order N°
Solidfix S3	50	35	DIN 1835 - E 16 16	140211

Zubehör Schlüssel:  
accessories:

Rev 12/08 // Erst.:tba , erstellt am 2014.07.24 // Prüf.:fre , geprüft am 2014.08.21

Änderungen vorbehalten, Subject to modification