

ext. 80 bar

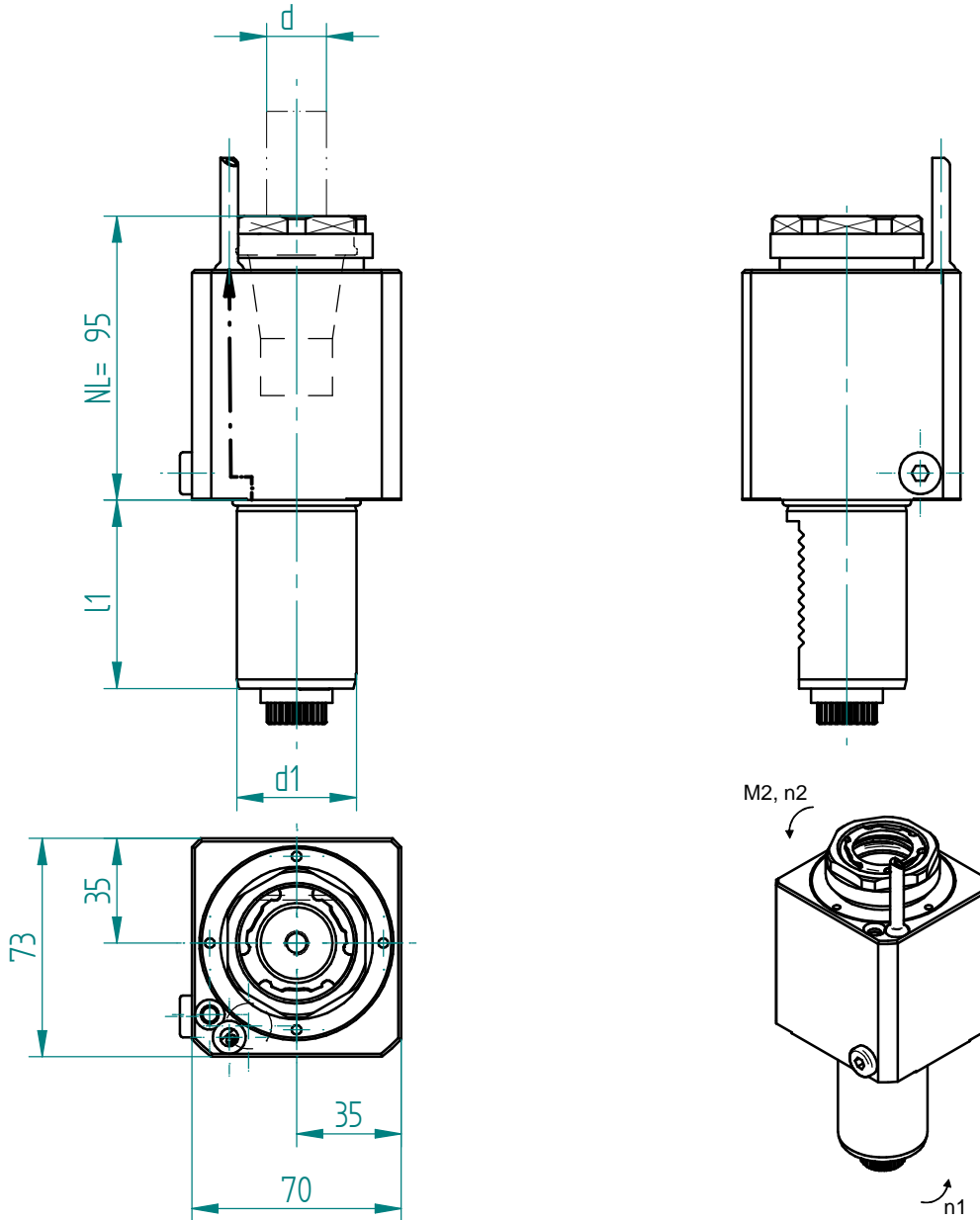

Schnittstelle Revolver <i>interface tool turret</i>		Kupplung <i>coupling</i>	Drehmoment <i>torque</i>	Drehzahl <i>tool speed</i>	Leistung <i>output</i>	Übersetzung <i>gear ratio</i>	Wkzg.Aufnahme Spannbereich <i>tool holding fixture clamping range</i>	Ausführung <i>version</i>	Bestell-Nr. <i>order N°</i>
Schaft <i>shank</i>	ISO 10889								
d1 mm	l1 mm		M2 max Nm	n2 max 1/min	P max KW	i = n1: n2	Spannbereich d <i>chucking capacity d</i>		
40	63	DIN 5480 W 20x0.8 x30x24	63.0	6000	10.0	1.00	ISO 15488 - 32 - I 2-20	neutral <i>neutral</i>	<b>101714</b>

Erforderliche(r) Schlüssel zur Werkzeugspannung / *necessary key(s) for tool clamping*

105763