

Typenblatt
Data Sheet

Modulares Spannsystem
Werkzeugaufnahme WELDON
modular clamping system ; tool location WELDON

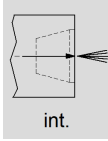

int. 80 bar
ext. bar

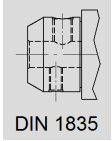
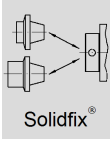
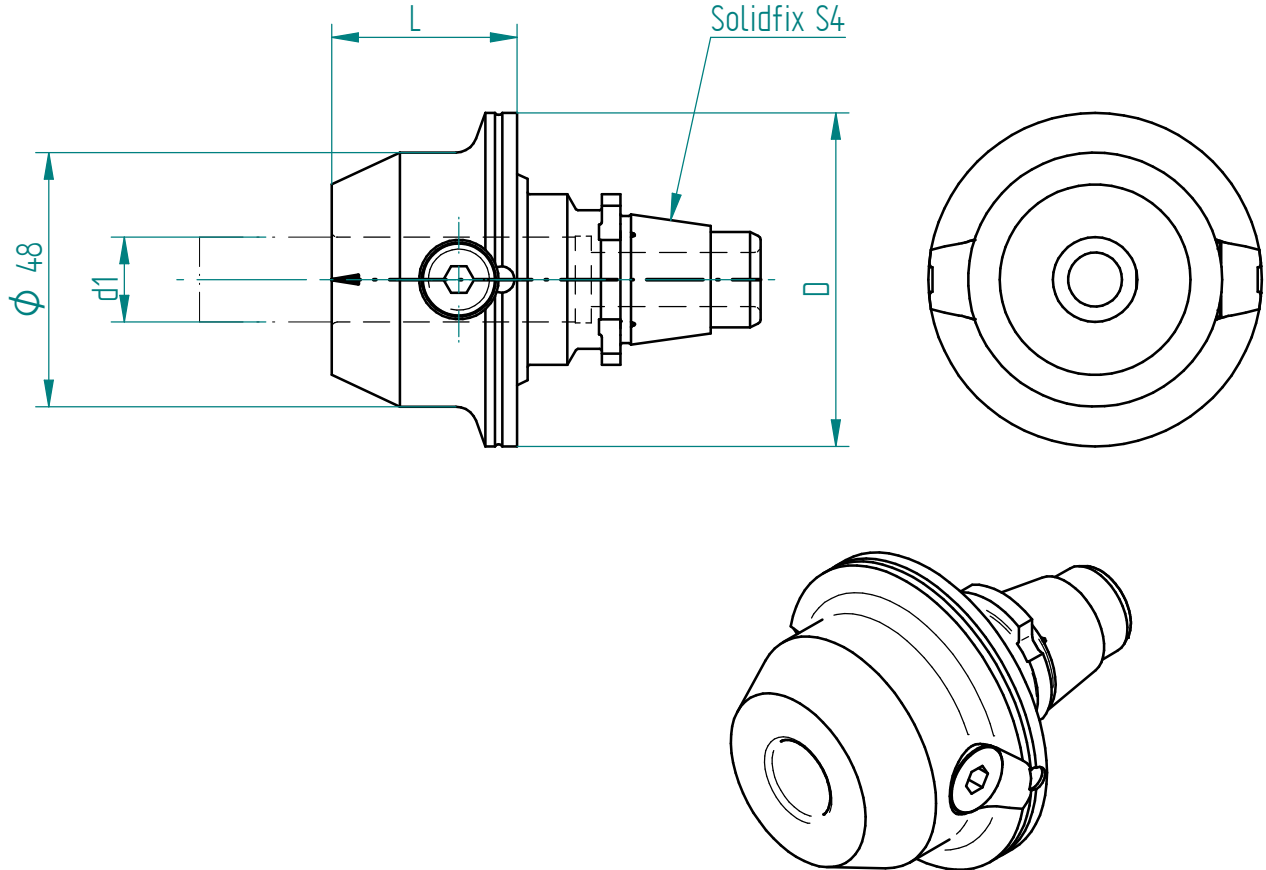

Schnittstelle Tooling <i>interface tooling</i>	D	L	Werkzeugaufnahme <i>tool location</i> Aufnahme d1 <i>location d1</i>	Bestell-Nr. <i>order N°</i>
Solidfix S4	63	35	DIN 1835 - B 16 16	140062

Zubehör Schlüssel:
accessories:

Rev 12/08 // Erst.:tba . erstellt am 2014.07.24 // Prüf.:fre . geprüft am 2014.08.19

Änderungen vorbehalten, Subject to modification